

# Monteringsanvisning Kruka Antracitgrå (103014)

Delar som ingår i kartongen:

(2x) Sida A

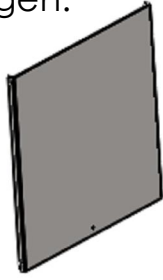

(2x) Sida B



Botten

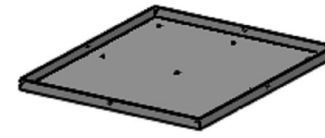

(12x) Skruv



(12x) Mutter



Steg 1:  
Skruva ihop Sida A, Sida B och  
Botten

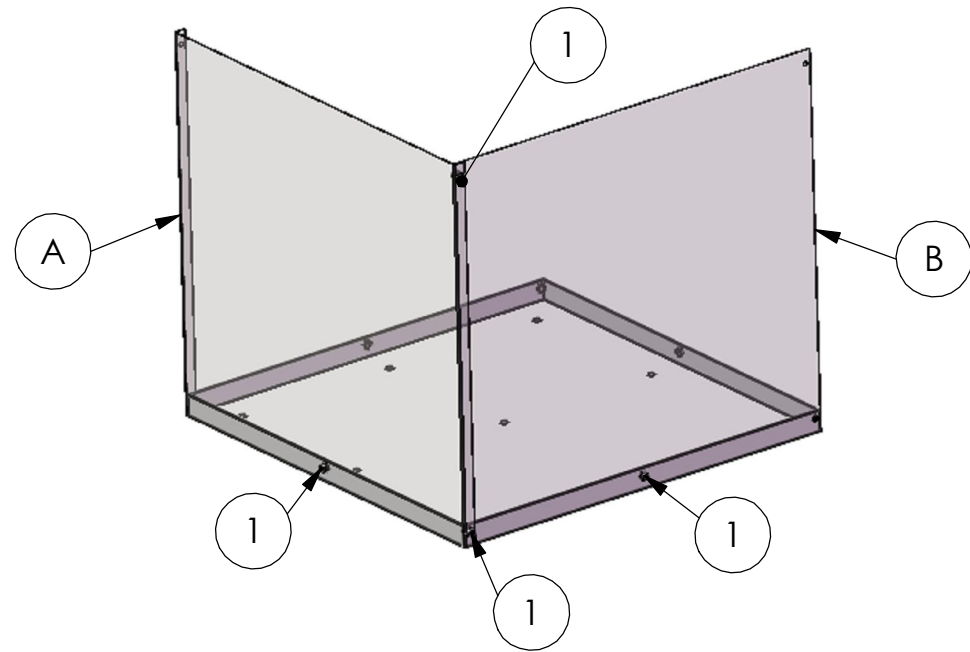

Steg 2:  
Skruva ihop Delar från steg 1 med  
Sida A

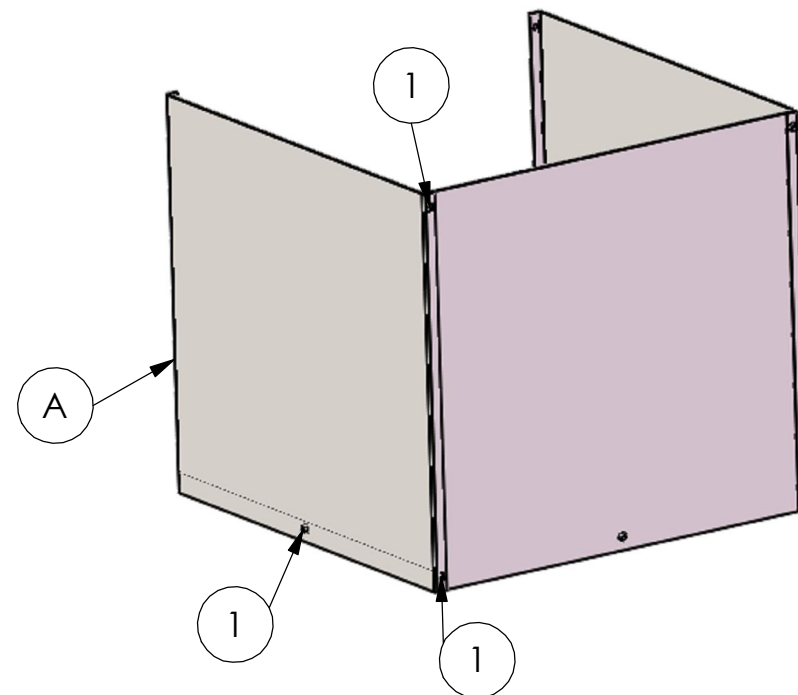

Steg 3:  
Skruva ihop Delar från steg 2 med  
Sida B

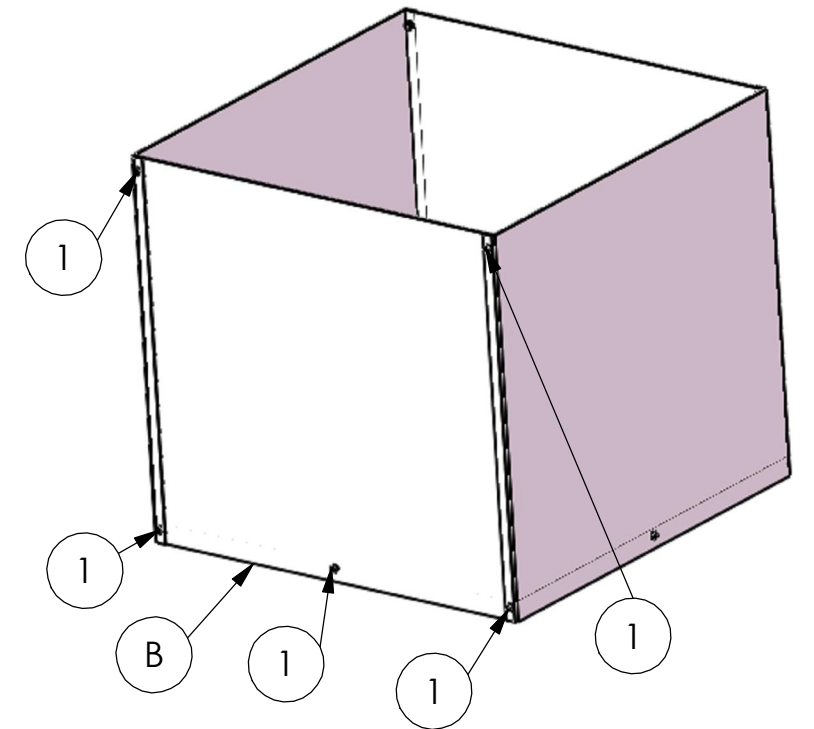

Alternativt kan botten skruvas fast i  
"högt läge"

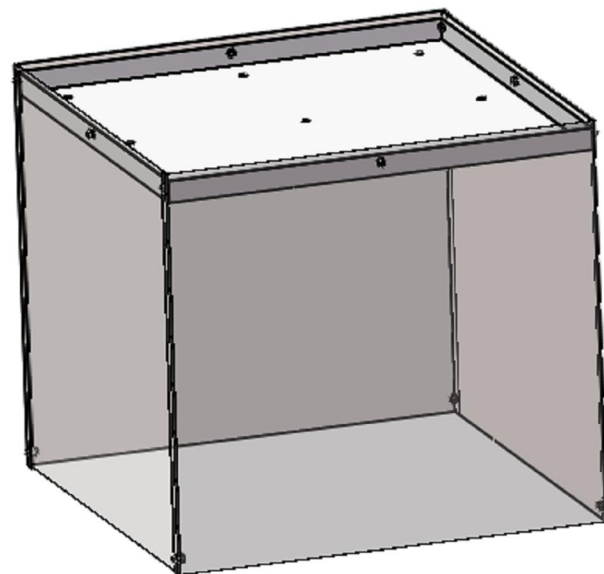

Klart!

