

Monteringsanvisning Kruka (103001)

Delar som ingår i kartongen:

(2x) Sida A



(2x) Sida B



Botten

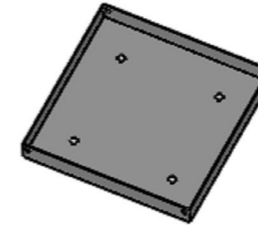

(12x) Skruv



(12x) Mutter



Steg 1:
Skruva ihop Sida A, Sida B och
Botten

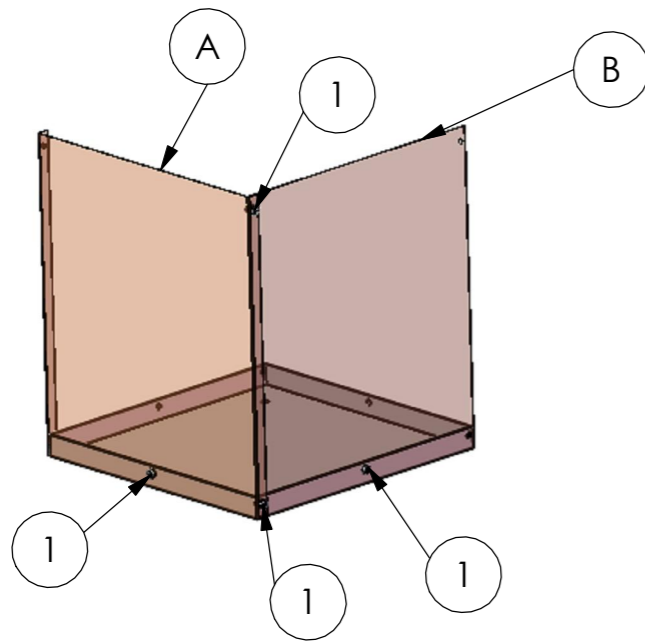

Steg 2:
Skruva ihop Delar från steg 1 med
Sida A

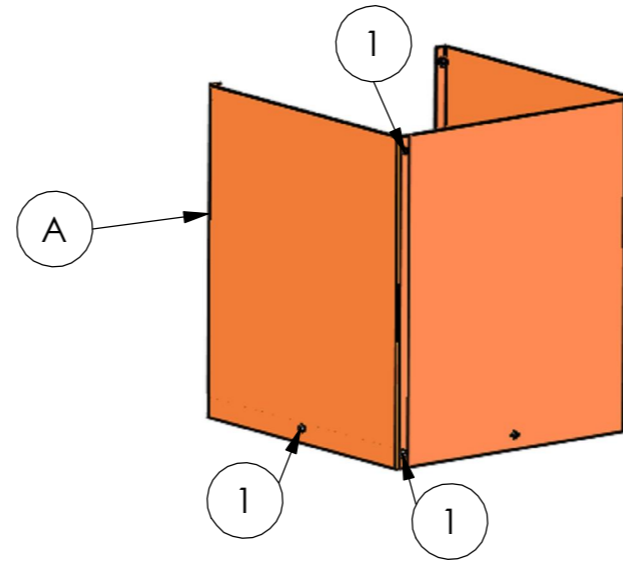

Steg 3:
Skruva ihop Delar från steg 2 med
Sida B

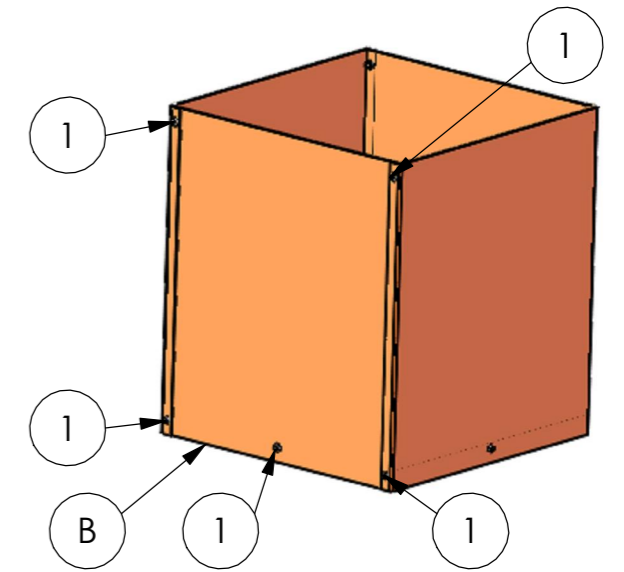

Alternativt kan botten skruvas fast i
"högt läge"

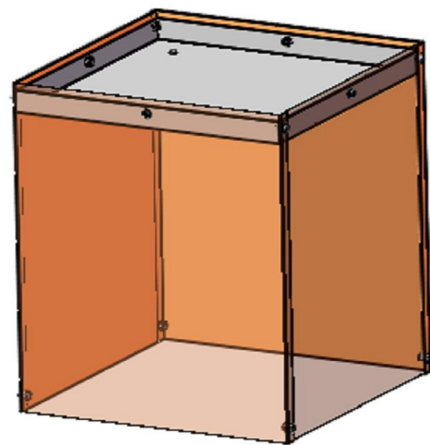

Klart!

